



Ramsey Winch Company OWNER'S MANUAL ATV Electric Winch Model ATV3000



ATV3000 WINCH					
LAYER OF CABLE	1	2	3	4	5
Rated line pull per layer (lbs)	3,000	2,500	2,100	1,890	1,680
(kgs)	1,350	1,133	952	857	761
Cumulative cable capacity per layer (ft)*	7	15	25	37	50
(3/16"-4.8 mm- dia. cable) (m)*	2.12	4.56	7.6	11.3	15.2

* CABLE MUST BE UNIFORMLY WOUND ONTO DRUM.

Line pull (lbs)	NO	500	1,000	1,500	2,000	2,500	3,000
first layer (kgs)	LOAD	227	453	680	906	1133	1360
Line speed (fpm)	20.8	17.6	15	12.3	10.2	8.5	5.0
first layer (mpm)	6.3	5.3	4.5	3.8	3.0	2.6	1.5
Amp draw (12v)	18	45	63	84	96	121	150

Congratulations

You have purchased the finest winch available in its service class. It features a highly efficient 3 stage planetary gear set which transmits torque from a permanent magnet motor. A safe positive clutch allows free spooling for quick cable deployment. Your Ramsey winch was designed and manufactured to provide you with the utmost in utility. As with any device that combines power and movement in its use, there are dangers if improperly used. At the same time, there are easier and faster ways for getting the job done if certain precautions are taken first. Please read this manual carefully. It contains useful ideas in obtaining the most efficient operation from your Ramsey Winch and safety procedures you need to know before beginning use. When you follow our guidelines for operation, your Ramsey winch will give you many years of satisfying service. Thank you for choosing Ramsey. You will be glad you have one working for you.

Please Note: Ramsey ATV 3000 winches are designed for ATV use. The winches are not designed for and should not be used in industrial applications (car haulers /carriers, wreckers, hoisting, etc.), and Ramsey does not warrant them to be suitable for such use. Ramsey makes a separate, complete line of winches for industrial/commercial use. Please contact the factory for further information.



CAUTION: Read and understand this manual before installation and operation of winch. See Safety Precautions.

Contents

Performance Specifications	cover
Safety Precautions	2
Tips for Safe Operation	2
Techniques of Operation	3
General Installation	3
Rotating the Motor	4-7
Operating Instructions	8
Maintenance	8
Cable Installation	8
Wireless Remote Control Operation	8
Trouble Shooting Guide	9
Winch Parts List (Wireless Remote)	10-11
Electrical Schematic (Wireless Remote)	11
Rocker Switch Operation	12
Rocker Switch Installation	12-14
Electrical Schematic (Rocker Switch)	13
Winch Parts List (Rocker Switch)	14-15
Warranty	back cover

Safety Precautions To Guard Against Possible Injury.....



- A. Keep yourself and others a safe distance to the side of the cable when pulling under load.
- B. Do not step over a cable, or near a cable under load.
- C. Use supplied hook strap when handling hook for spooling wire rope.
- D. Do not use the ATV to pull a load on the winch cable. This could result in cable breakage and/or winch damage
- E. Use a heavy rag or gloves to protect hands from burrs when handling winch cable.
- F. Apply blocks to wheels when ATV is on an incline.
- G. Winch clutch should be disengaged when winch is not in use and fully engaged when in use.
- H. Modification, alteration, or deviation to the winch should only be made by Ramsey Winch Company.

Tips for Safe Operation

- I. Keep the duration of your pulls as short as possible. If the motor becomes uncomfortably hot to the touch, stop and let it cool for a few minutes. Do not pull more than one minute at or near the rated load. Do not maintain power to the winch if the motor stalls. Electric winches are for intermittent usage and should not be used in constant duty applications.
 - J. Do not use winch in hoisting applications due to required hoist safety factors and features.
 - K. Do not exceed maximum line pull ratings shown in tables. Shock loads must not exceed these ratings.
 - L. To respool correctly, it is necessary to keep a slight load on the cable. Do not allow the cable to slip through your hand and do not approach the winch too closely. When all the cable except a few feet is in, stop and finish spooling in cable by rotating the drum by hand with clutch disengaged. Always use hook strap to hold hook when spooling.
- Don't underestimate the potential danger in winching operations. Neither should you fear them. Do learn the basic dangers and avoid them.
- Observe spooling of cable onto drum. Side pulls can cause cable to pileup at one end of the drum. To correct uneven stacking, spool out that section of the cable and move it to the other end of the drum and continue winching. Uneven spooling which causes cable pileup can interfere with the winch tie rods causing damage to the winch.
- Store the wireless remote control transmitter in a safe place where it will not become damaged. Inspect it before you use it.
- When ready to begin winching, push and hold the On/Off button on the transmitter until it flashes. Do not engage clutch with motor running.
- Never connect the hook back to the cable. This

causes cable damage. Always use a sling or chain of suitable strength.

Observe your winch while winching. If possible, while standing at a safe distance. If you use ATV drive to assist, stop and get off every few feet to assure the cable is not piling up in one corner. Jamming cable can break your winch.

Do not attach tow hooks to winch mounting apparatus. They must attach to ATV frame.

When double lining during stationary winching, the winch hook should be attached to the chassis of the ATV. Since the greatest pulling power is achieved on the innermost layer of your winch, it is desirable to pull off as much line as you can for heavy pulls. If this is not practical, use a snatch block and double line arrangement.

Neat, tight spooling avoids cable binding which is caused when a load is applied and the cable is pinched between two other wraps of cable. If this happens, alternately power the winch in and out a few inches. Do not attempt to work a bound cable under load, free by hand.

Techniques of Operation

The best way to get acquainted with how your winch operates is to make a few test runs before you actually need to use it. Plan your test in advance. Remember you hear your winch as well as see it operate. Get to recognize the sound of a light steady pull, a heavy pull, and sounds caused by load jerking or shifting. Soon you will gain confidence in operating your winch and its use will become second nature with you.

Your winch will not only pull your ATV up or ease your ATV down a steep grade, it will also pull another ATV or a load while your ATV is anchored in a stationary position.

When pulling a heavy load, place a blanket, jacket or tarpaulin over the cable five or six feet from the



For basic self-recovery, anchor to a tree or heavy rock. When anchoring to a tree, always use a tree trunk protector.

hook. It will slow the snap back in the event of a broken cable.

Use the ATV wheel power to help the winch, but don't overtake the winch line. Plan your pull. You can't always hook up and pull out in one step. Examine all the areas for anchoring possibilities as well as leverage situations, direction, and goal.

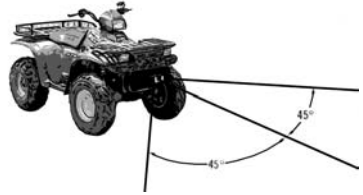

Winches equipped with cable guide fairleads can pull from several directions. Pull from an angle only to straighten up the ATV—otherwise you can damage structural members or other parts of your ATV and cause excess cable buildup on one end of the winch drum.

General Installation

The winch shown in this owner's manual is solely and exclusively designed for ATV mounted, non-industrial applications. All other applications will void warranty.

1. Install Winch and Mounting Kit according to instructions supplied with Mounting Kit. Tighten mounting bolts to 16 ft-lbs torque.
2. **It is very important that the winch be mounted on a flat surface, with the cable feeding from the bottom of the drum.**

CAUTION: SUPPLIED 7/8" LONG MOUNTING BOLTS WITH LOCK-WASHERS ARE FOR A RECOMMENDED WINCH MOUNTING PLATE THICKNESS OF 3/16". IF A DIFFERENT MOUNTING PLATE THICKNESS IS USED, THE BOLT LENGTH MUST BE ADJUSTED ACCORDINGLY OR DAMAGE TO WINCH MAY OCCUR. REPLACEMENT BOLTS MUST BE SAE GRADE 5 OR EQUIVALENT.

3. Do not attach motor and battery leads until instructed to do so.
4. Refer to installation instructions for the Wireless Remote Switch (in the *ATV Wireless Installation and Operation Manual*) for installation of the switch and electrical assemblies for the winch.

Rotating the Motor on your ATV Winch

The ATV winch has the motor studs and leads positioned on the end of the motor aligned vertically. If you need to rotate the motor on your ATV winch to gain clearance, you can rotate the motor 90°. The motor studs will then be aligned horizontally.

Before you begin:

Note: If you have installed the optional Brake kit (P/N 256116) for the ATV winch, make sure you have the Brake kit installation instructions before proceeding. You will need to re-install the Brake kit after you rotate the motor (step 6 on the following pages). Contact Ramsey if you do not have your installation instructions.

1. Remove the cable from the drum. Turn the clutch handle to Freespool and pull cable off. Slide the end of the cable out of the pocket next to the drum flange until the cable anchor can be removed. Be sure to keep the cable anchor for re-installing the cable. Leave the clutch set to Freespool.
2. Disconnect the motor leads.
3. Remove the winch from its mounting channel. Place it on a sturdy, level workbench.

Set the winch down on the clutch end.

1. Remove the tie bar bolts and nuts. Pull tie bars from between end bearings.
2. Lift the motor end off the drum and set down with the motor end down. Make sure the shaft, drum bushing and spring stay with the drum.

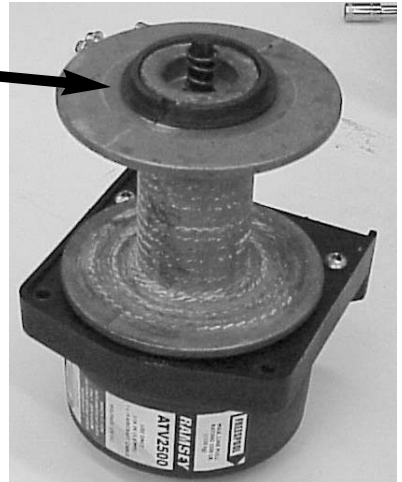
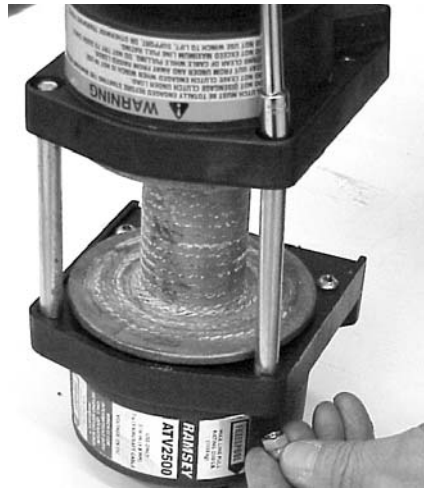

3. Remove the bolts that hold the end plate to the motor end housing. Lift off the end plate and take the nuts and washers out of the mounting feet. Set aside the gear assemblies and bushing. The input sun and planetary gear carrier may come out together.

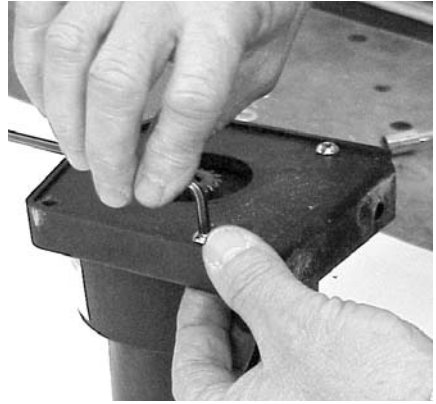

4. Lean the motor end and loosen the motor tie bolts off the tie bolt nuts. Lean the motor end back up so that it is sitting upright. **Do not let the motor end cap come apart from the rest of the motor.** Lift the motor end housing and rotate 90°. Put the tie bolt nuts in the other set of pockets and carefully lean the motor end back. Tighten the tie bolts to 45-50 in-lbs. torque. Do not overtighten.

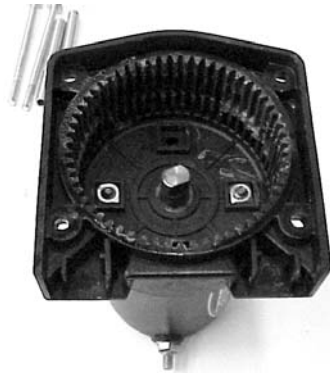

5. After rotating the motor, the motor end will appear as shown at right. The motor studs will be aligned horizontally, and the motor tie bolt nuts will be in the other set of pockets.

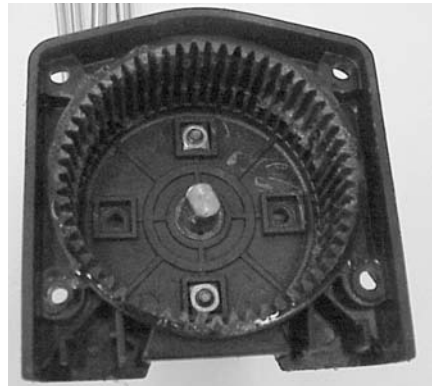

6. Replace the gears into the motor end housing, fitting the input sun gear over the motor shaft. The planetary gear carrier should be seated so that the bushing, as shown at lower right, is flush with the ring gear.

7. Re-install the end plate on the housing with the bolts you removed earlier. Tighten these bolts to 45-50 in-lbs. torque. Do not over-tighten.

8. Lift the motor end assembly onto the drum. Turn the drum and motor end assembly so that the shaft fits into the input sun gear.

Lean the motor end assembly slightly to one side to insert the tie bars into their holes.

9. Slide the tie bar bolts through the tie bars and into their nuts. Tighten the tie bar bolts to 45-50 in-lbs. torque. Do not over tighten. The finished winch should look as shown below, with the motor studs aligned horizontally.

Confirm that the drum freespools properly without binding.

Refer to the winch mounting kit installation instructions for re-installing the winch. Re-install the winch cable according to the instructions in this manual.

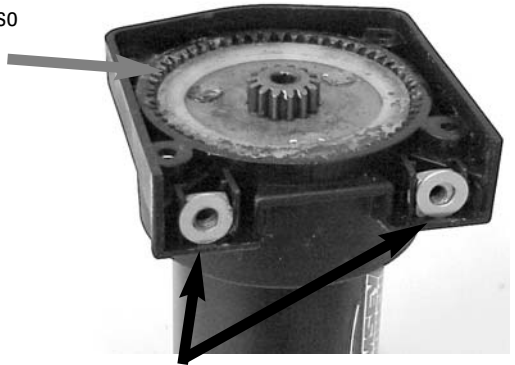

Insert the mounting nuts and washers into the pockets of the housing as shown. Make sure they do not fall out while re-installing the end plate.



NOTES

Operating Instructions

The winch clutch allows rapid unspooling of the wire rope for hooking onto the load or anchor point. The clutch is operated by the shifter located on the end of the winch as follows:

1. To disengage the clutch, turn the clutch shifter to the "FREESPOOL" position. Wire rope may now be freespooled off the drum.
2. To engage the clutch, turn the clutch shifter to the "ENGAGE" position. The winch is now ready for pulling.



Your battery must be kept in good condition. A fully charged battery and proper connections are essential. Run the ATV engine during winching operations to keep battery charged.

Maintenance

Corrosion on electrical connections will reduce performance or may cause a short. Clean all connections. In salty environments use a silicone sealer to protect from corrosion.

To minimize corrosion of the internal motor components that may occur due to condensation, power the winch in or out periodically. Energizing the motor will generate heat, which will help dissipate any moisture buildup in the motor. This should be performed at periodic intervals (such as with each oil change of your vehicle). Note: Refer to Troubleshooting Guide if the motor has been submerged.

See supplied instructions for programming a replacement transmitter.

All moving parts in the winch are permanently lubricated with broad temperature range lithium based grease. Lubricate cable periodically using light penetrating oil. Inspect for broken strands and replace if necessary. If the cable becomes worn or damaged, it must be replaced.

Cable Installation

Note: Cable should be installed so that it feeds from the bottom of the drum.

Unwind the new cable by rolling it out along the ground to prevent kinking. Remove old cable and observe the manner in which it is attached to the cable drum flange, watching carefully for the cable anchor puck.

Before installing the new cable assembly, securely wrap the end of the cable with tape to prevent fraying.

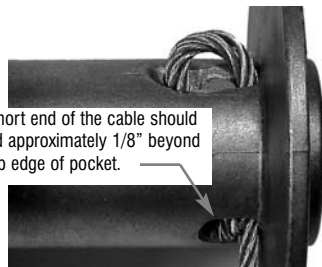

Slide the cable through narrow end of the pocket against drum flange and wrap the cable around the anchor puck. Pull the cable and anchor back into the wide end of the pocket leaving approximately 1/8" beyond edge of pocket as shown. Use a hammer and drift punch to drive the back side of the wire rope, firmly seating the wire rope and anchor into the pocket.

Wind on the cable by pulling in a light load to keep the tension constant. Allow the cable to swivel by using a length of chain or a swivel block between the cable hook and the load.

Wireless Remote Control Operation

Caution: When the transmitter reaches a temperature below 0°F (-18°C) it will not operate. In extremely cold temperatures, keep transmitter in a pocket of innermost layer of clothing when not in use.

The transmitter has push buttons labeled according to their function. Make sure the motor has stopped fully before reversing to prevent premature solenoid failure. To operate the winch hold "ON/OFF" button for 2 seconds to activate the "IN and "OUT" functions. Run winch forward and reverse to check connection and to verify winch operating directions. The transmitter is clearly labeled and a red LED flashes when the winch is in operation. Pushing both buttons at the same time will not damage your winch in any way. Press and hold the "ON/OFF" button on the transmitter to disable the transmitter when winch is not in use. This will prolong the battery life of the transmitter. The transmitter automatically turns off after 20 minutes.

Refer to page 5 of Remote Control Installation Instructions for remote operation notes.



ATV3000 Trouble Shooting Guide

CONDITIONS	POSSIBLE CAUSE	CORRECTION
MOTOR RUNS IN ONLY ONE DIRECTION	Defective solenoid or stuck solenoid.	Jar solenoid assembly to free contacts. Check each solenoid by applying +12 volts to coil terminal (it should make an audible click when energized).
	Defective remote control or low battery in transmitter.	Check winch operation with auxiliary toggle switch. Check battery in transmitter.
	Defective Rocker Switch	Replace Rocker Switch
MOTOR RUNS EXTREMELY HOT	Long period of operation	Cooling-off periods are essential to prevent overheating.
MOTOR RUNS, BUT WITH INSUFFICIENT POWER OR WITH LOW LINE SPEED	Insufficient battery	Test for faulty vehicle battery.
	Bad connection	Check battery cable for corrosion; clean and grease
	Insufficient charging system	Replace with larger capacity charging system.
MOTOR RUNS, BUT DRUM DOES NOT TURN	Clutch not engaged	If clutch engaged but symptoms still exist, it will be necessary to disassemble winch to determine cause and repair.
MOTOR WILL NOT OPERATE	Defective solenoid or stuck solenoid.	Jar solenoid assembly to free contacts. Check solenoid by applying 12 volts to coil terminal (it should make an audible click when energized).
	Defective remote control or low battery in transmitter.	Check winch operation with auxiliary toggle switch. Check transmitter battery.
	Defective Rocker Switch.	Replace Rocker Switch.
	Defective motor	If solenoids operate, check for voltage at armature post; replace motor.
	Loose connections.	Check all electrical connections from the battery to the motor.
MOTOR WATER DAMAGED	Submerged in water or water from high pressure car wash	Allow to drain and dry thoroughly, then Run motor without a load in short bursts to dry windings.
WINCH RUNS IN OPPOSITE DIRECTION OF TRANSMITTER BUTTONS	Motor leads crossed.	Reverse electrical connections to motor.
	Solenoid control wires crossed.	Reverse position of green and yellow wires on solenoid assembly.

RAMSEY ATV3000 (Wireless Remote)

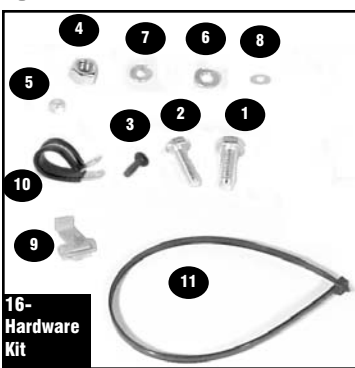
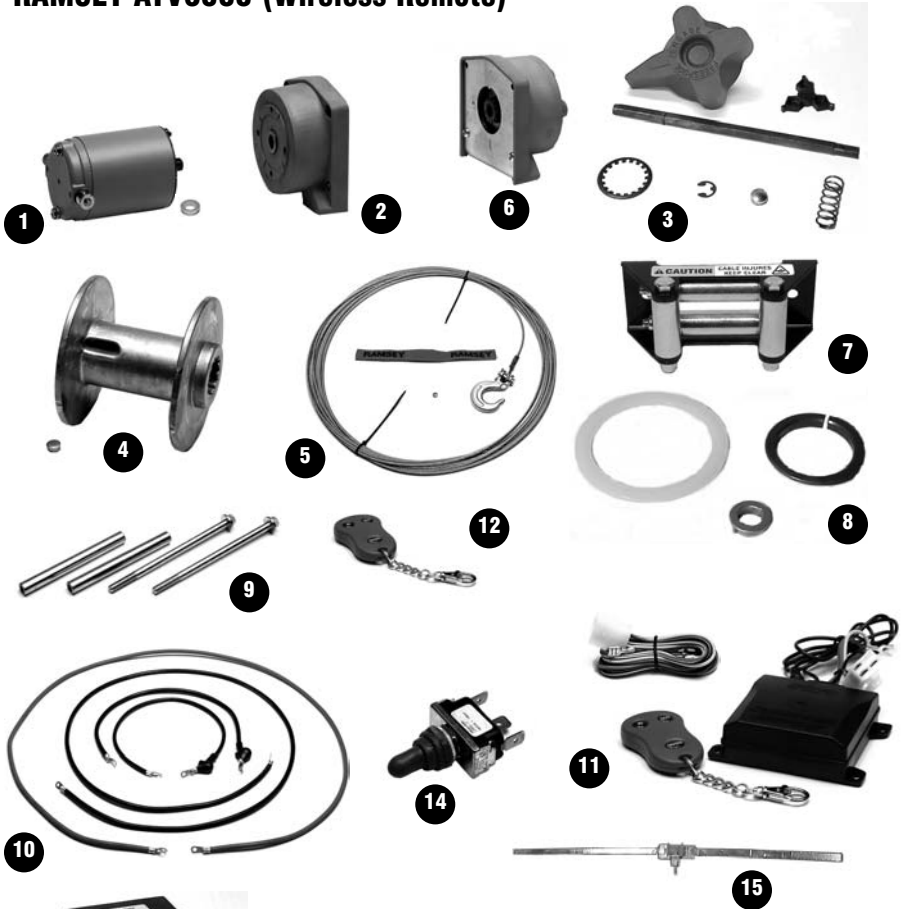

***Hardware Kit**

Item No.	Qty.	Description
16-1	4	5/16-18UNC x 1" Hx Hd Z/P GR5 Capscrew
16-2	2	3/8-16UNC x 3/4" Hx Hd Z/P GR5 Capscrew
16-3	2	#10-24UNC x 3/4" Truss Cross-recess F/B Capscrew
16-4	2	3/8-16UNC Hx GR2 Z/P Nut
16-5	2	#10-24UNC Hx Locknut
16-6	4	5/16 Med Z/P Lockwasher
16-7	2	3/8 Med Z/P Lockwasher
16-8	2	#10 Flat Washer Z/P
16-9	1	Wire Splice
16-10	2	Tube Clamp
16-11	1 pkg	Cable Ties

Winch Parts List ATV3000 (Wireless Remote)

ITEM NO.	QTY.	PART NO.	DESCRIPTION
1	1	251214	MOTOR KIT
2	1	251189	MOTOR END GEAR SET
3	1	251191	CLUTCH KIT
4	1	251192	CABLE DRUM KIT
5	1	251193	CABLE & HOOK KIT
6	1	251194	CLUTCH END GEAR KIT
7	1	251236	ROLLER FAIRLEAD (ON CERTAIN MODELS)
8	1	251195	BUSHING KIT
9	1	251196	TIE BAR KIT
10	1	251197	ELECTRICAL WIRING KIT
11	1	282058	WIRELESS RECEIVER & TRANSMITTER KIT
12	1	251190	WIRELESS TRANSMITTER
13	1	251234	SOLENOID KIT
14	1	251235	TOGGLE SWITCH
15	1	251198	ANTENNA KIT
16	1	257522	HARDWARE KIT*

Electrical Schematic (Wireless Remote)

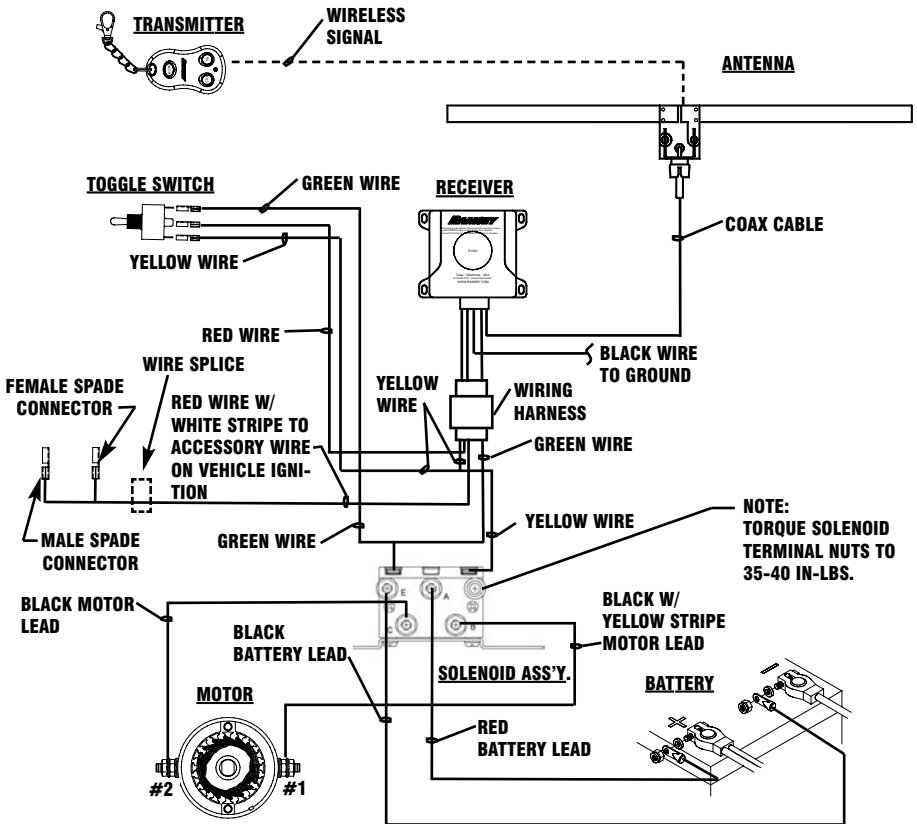

Rocker Switch Operation

Press Rocker Switch toward “IN” position to spool cable “IN” and press Rocker Switch toward “OUT” position to spool cable “OUT”.

Rocker Switch Installation

The Rocker Switch will mount to the handle bars of the ATV.

Before Beginning Installation

1. Install mounting kit and winch according to the mounting kit instructions.
2. **Disconnect negative (-) battery cable from battery. Turn off vehicle ignition.**
3. **Disengage winch clutch.**
4. Remove hood or cowling as necessary for easier access to installation area.
5. Locate and mark mounting location for Solenoid Assembly.
6. Locate accessory wire from vehicle ignition switch that is powered only when ignition is ON. Use this wire when splicing to Red wire on Rocker switch.
7. Make sure locations are close enough for wiring connections to be made without making alterations to wire lengths.

CAUTION: DO NOT CONNECT NEGATIVE BATTERY CABLE OR ENGAGE CLUTCH UNTIL INSTALLATION IS COMPLETE. WINCH COULD BEGIN SPOOLING CABLE UNEXPECTEDLY CAUSING INJURY OR DAMAGE TO WINCH.

Note: For certain mounting applications, where the solenoid needs to be mounted at the rear of the vehicle, switch the battery and motor leads. This will allow the longer leads to reach the winch at the front of the vehicle.

Solenoid Mounting: Choose a mounting location that will remain protected and dry. Solenoid should be mounted on a flat surface.



Installing the Solenoid

1. Use Solenoid Assembly as a guide to mark and drill (2) 7/32” holes in location determined for solenoid.
2. Use (2) 3/4” long #10 capscrews (item #14-3), (2) #10 flat washers (item #14-8), and (2) #10 locknuts (item #14-5) to mount solenoid. Tighten to 60 in-lbs (7 Nm) torque.

Installing the Rocker Switch

For clarification, see wiring schematic on page 9.

1. Position Tube Clamp (item #14-12) on handle bars in convenient location.



2. Mount Rocker Switch housing to Tube Clamp using #10 capscrew, locknut, flat washer, and shake-proof washer (items #14-3, #14-5, #14-8, and #14-9). Tighten securely.
3. Push the Green, Red, and Yellow wires through the back of the switch housing.

Electrical Schematic (Rocker Switch)

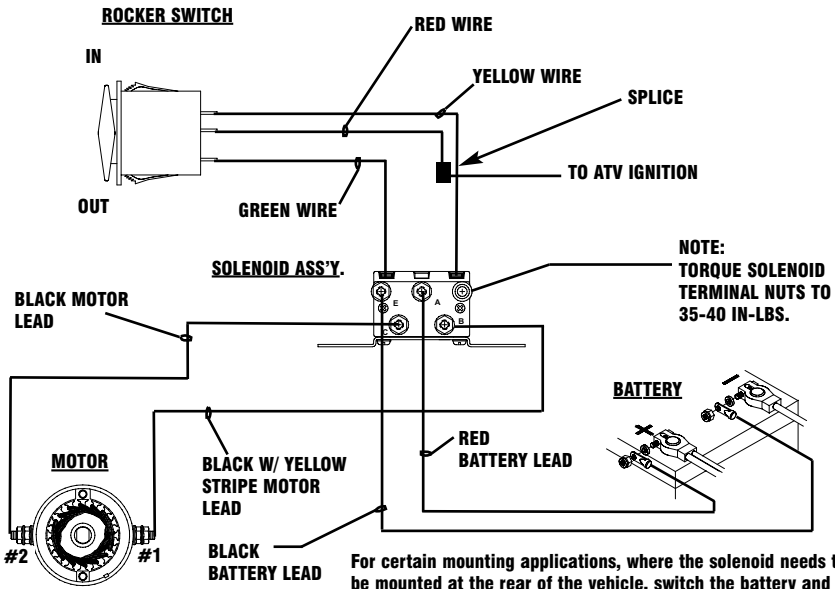

For certain mounting applications, where the solenoid needs to be mounted at the rear of the vehicle, switch the battery and motor leads. In this case, connect the black w/yellow stripe lead to the positive (+) terminal of the battery, and the longer black lead to the negative (-) terminal. Connect the red lead and the shorter black lead to the motor terminals.

4. Install the Gasket onto the Rocker Switch.

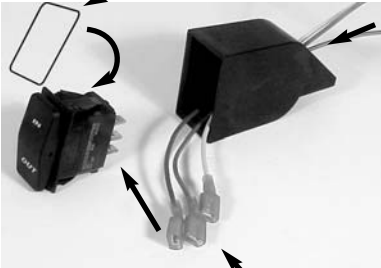

5. Connect Yellow wire (item #12-3) to top terminal on Rocker Switch (terminal behind "IN" position). Connect Red wire (item #12-1) to middle terminal on Rocker switch. Connect Green wire (item #12-2) into bottom terminal of Rocker switch.
6. Slide Green, Yellow, and Red wires into loom (item #12-4). Slide loom up to back of the switch housing.
7. Snap switch and switch housing together.
8. Push Accessory wire from ignition and other end of Red wire into plastic Splice.

9. Fold splice clip over itself and snap closed.
10. Route wires from Rocker Switch down the handle bars. Turn the handle bars fully right and left to ensure plenty of clearance.
11. Make sure wires are not drawn taut across any surfaces that could damage them. Use cable ties to anchor wires. Tie off excess.

Connect Wiring to Solenoid (unless motor and battery leads are switched)

CAUTION: TIGHTEN NUTS ON TERMINAL STUDS TO 35-40 IN-LBS. (3-4 Nm) TORQUE. DO NOT OVER-TIGHTEN.

1. Connect Red Battery Lead (Item #13-2) between "A" terminal on Solenoid and positive (+) vehicle battery terminal.
2. Connect Black Motor Lead (item #13-4) between #2 terminal on motor and C terminal on solenoid. Connect Black w/Yellow Stripe Motor Lead (item #13-1) between #1 terminal on motor and B terminal on solenoid.
3. Connect Black Battery Lead (item #13-3) to "E" terminal on Solenoid and route to negative (-) vehicle battery terminal **but do not connect.**

4. Plug Yellow wire from switch into right terminal (terminal above black with yellow stripe motor lead). Plug Green wire from switch into left terminal (terminal above black motor lead).

Finish Installation

1. Confirm that winch clutch is disengaged.
2. Connect negative (-) battery cable to vehicle battery. Connect Black Battery Lead from winch to negative (-) vehicle battery terminal.
3. With ignition switch OFF, press Rocker switch to "OUT"—winch should not operate. If the

winch does operate with the ignition off, confirm that proper accessory wire from ignition was spliced.

4. Spool a few feet of cable out by hand. Engage winch clutch. Turn ignition switch ON and press Rocker switch to "OUT"—winch should spool cable out.
6. If winch does not operate with ignition on, check wiring to the schematic on page 14.
7. If winch spools cable IN instead of OUT, turn off ignition and reverse yellow and green wires on solenoid.

ATV3000 (Rocker Switch) Parts List

ITEM NO.	QTY.	PART NO.	DESCRIPTION
1	1	251214	MOTOR KIT
2	1	251189	MOTOR END GEAR SET KIT
3	1	251191	CLUTCH KIT
4	1	251192	CABLE DRUM KIT
5	1	251193	CABLE & HOOK KIT
6	1	251213	CLUTCH END GEAR KIT
7	1	251236	ROLLER FAIRLEAD KIT
8	1	251195	BUSHING KIT
9	1	251196	TIE BAR KIT
10	1	251234	SOLENOID KIT
11	1	257536	ROCKER SWITCH KIT
12	1	299728	SWITCH WIRING KIT ¹
13	1	299724	SOLENOID WIRING KIT ²
14	1	257535	HARDWARE KIT ³

1. **Switch Wiring Kit**, as shown on facing page, consists of the following components:

ITEM NO.	QTY.	DESCRIPTION
12-1	1	123" RED WIRE
12-2	1	123" GREEN WIRE
12-3	1	123" YELLOW WIRE
12-4	1	24" LOOM

2. **Solenoid Wiring Kit**, as shown on facing page, consists of the following components:

ITEM NO.	QTY.	DESCRIPTION
13-1	1	37" MOTOR LEAD - BLACK W/YELLOW STRIPE
13-2	1	97" BATTERY LEAD - RED
13-3	1	97" BATTERY LEAD - BLACK
13-4	1	37" MOTOR LEAD - BLACK

ATV3000 (Rocker Switch)

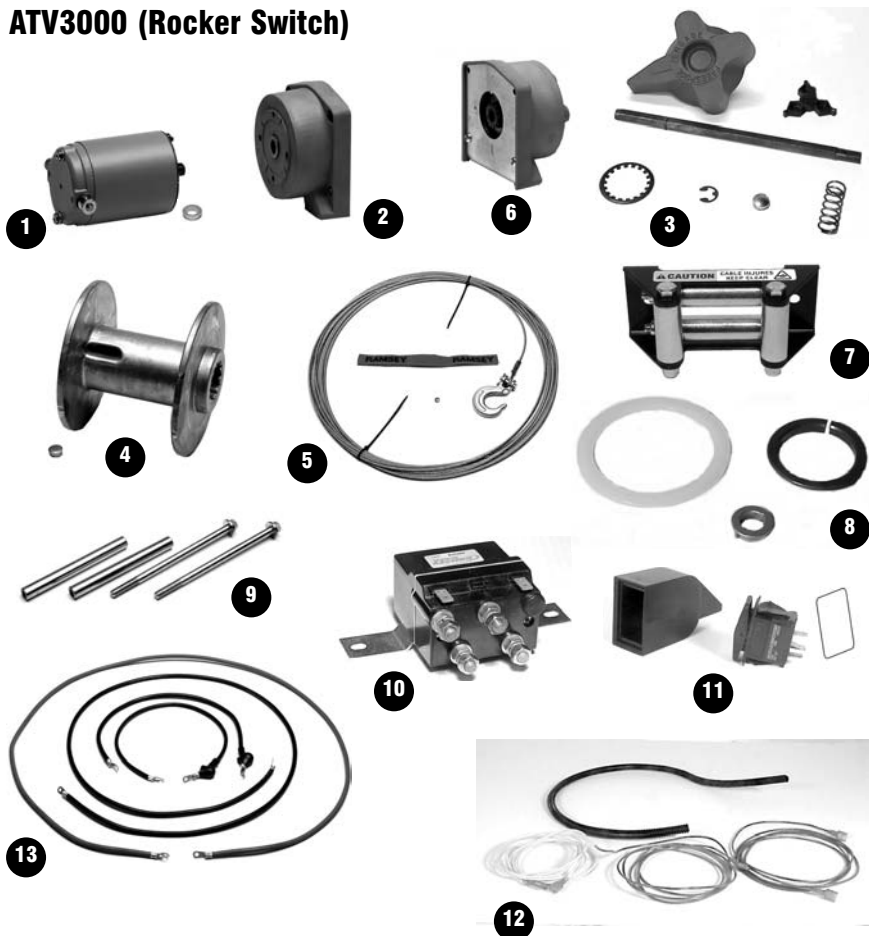

3. **Hardware Kit** consists of the following components:

ITEM NO.	QTY.	DESCRIPTION
14-1	4	5/16-18UNC X 1" LG HX HD Z/P CAPSCREW
14-2	2	3/8-16UNC X 1" LG HX HD GR5 Z/P CAPSCREW
14-3	3	#10-24NC X 3/4 LG TR CROSS RECESS F/B CAPSCREW
14-4	2	3/8-16UNC REG HX HD GR2 Z/P NUT
14-5	3	#10-24NC HEX LOCK NUT
14-6	4	5/16" MED Z/P LOCK WASHER
14-7	2	3/8" MED Z/P LOCK WASHER
14-8	3	#10 Z/P FLAT WASHER
14-9	1	#10 SHAKE-PROOF WASHER
14-10	1	WIRE SPLICE
14-11	1 PKG	CABLE TIES (12 EA)
14-12	1	TUBE CLAMP

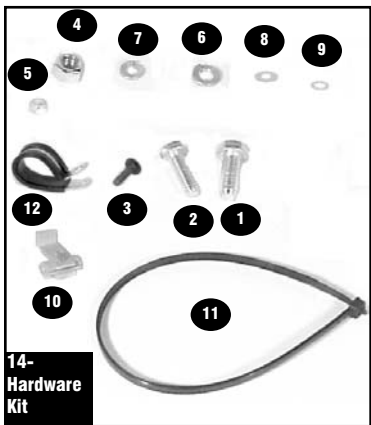

Warranty Information

Ramsey Winches are designed and built to exacting specifications. Care and skill go into every winch we make. If the need should arise, warranty procedure is outlined on the back of your self-addressed, postage paid warranty card. Please read and fill out the enclosed warranty card and send it to Ramsey Winch Company. If you have any problems with your winch, please follow instructions for prompt service on all warranty claims.

Limited Lifetime Warranty

Ramsey Winch offers a limited lifetime warranty for each new Ramsey ATV winch against manufacturing defects in workmanship and materials on all manufactured components.

Warranty registration cards for each winch must be submitted at the time of purchase, or within 90 days. Online registration of your winch is available at www.ramsey.com.

New cable assemblies are warranted against defects in workmanship and materials. No warranty applies after initial use.

All Ramsey mounting kits and other accessories carry a 1- year limited warranty against defects in materials and workmanship.

This warranty is void if winch is used in industrial applications.

Electrical components consisting of motors, solenoids, wiring, wire connectors, and associated parts carry a limited 1-year warranty.

The obligation under this warranty, statutory or otherwise, is limited to the replacement or repair at the manufacturers factory, or at a point designated by the manufacturer, of such part as shall appear to the manufacturer, upon inspection of such part, to have been defective in material or workmanship. This Warranty does not obligate Ramsey Winch Company to bear the cost of transportation charges in connection with the replacement or repair of defective parts, nor shall it apply to a product upon which repairs or alterations have been made, unless authorized by the manufacturer, or for equipment misused, neglected, or improperly installed.

Important notice: To the fullest extent permitted by applicable law, the following are hereby excluded and disclaimed: **1. All warranties of fitness for a particular purpose; 2. All warranties of merchantability; 3. All claims for consequential or incidental damages. There are no warranties that extend beyond the description that appears on the face hereof.**

Some states do not allow the above exclusions or disclaimers in consumer transactions and as such this disclaimer/exclusion may not apply to your particular case.

To the extent such warranties of fitness for a particular purpose or merchantability are deemed to apply to this product, they exist only for so long as the express limited warranty elsewhere set forth is in existence.

Ramsey Winch Company makes no warranty in respect to accessories, same being subject to the warranties of their respective manufacturers.

Ramsey Winch Company, whose policy is one of continuous product improvement, reserves the right to improve any product through changes in design or materials as it may deem desirable without being obligated to incorporate such changes in products of previous manufacture.

If field service at the request of the buyer is rendered and the fault is found not to be with Ramsey Winch Company's product, the buyer shall pay the time and expense of the field representative. Bills for service, labor or other expenses which have been incurred by the buyer without express approval or authorization by Ramsey Winch Company will not be accepted.

This Warranty gives you specific legal rights and you may also have other legal rights which vary from state to state.



RAMSEY WINCH COMPANY
P.O. BOX 581510 TULSA, OKLAHOMA 74158-1510 USA PHONE: (918) 438-2760 FAX: (918) 438-6888
<http://www.ramsey.com>

OM-914053-0105-R